



Magnetic Autocontrol GmbH

Grienmatt 20
D-79650 Schopfheim
Tel. 07622 695 644

Job number 5526,0002

Type MicroDrive

MHTM - MicroDrive - switch clock 1-channel
ZS1K01 24V

Number of pages 5

				06.12.2011
				gp
01	16.04.14	5K14513	gp	
Version	Date	Modification project	Name	00 5K11567

MHTM
MicroDrive



Cover sheet

5526,0002

Page 1
of 5

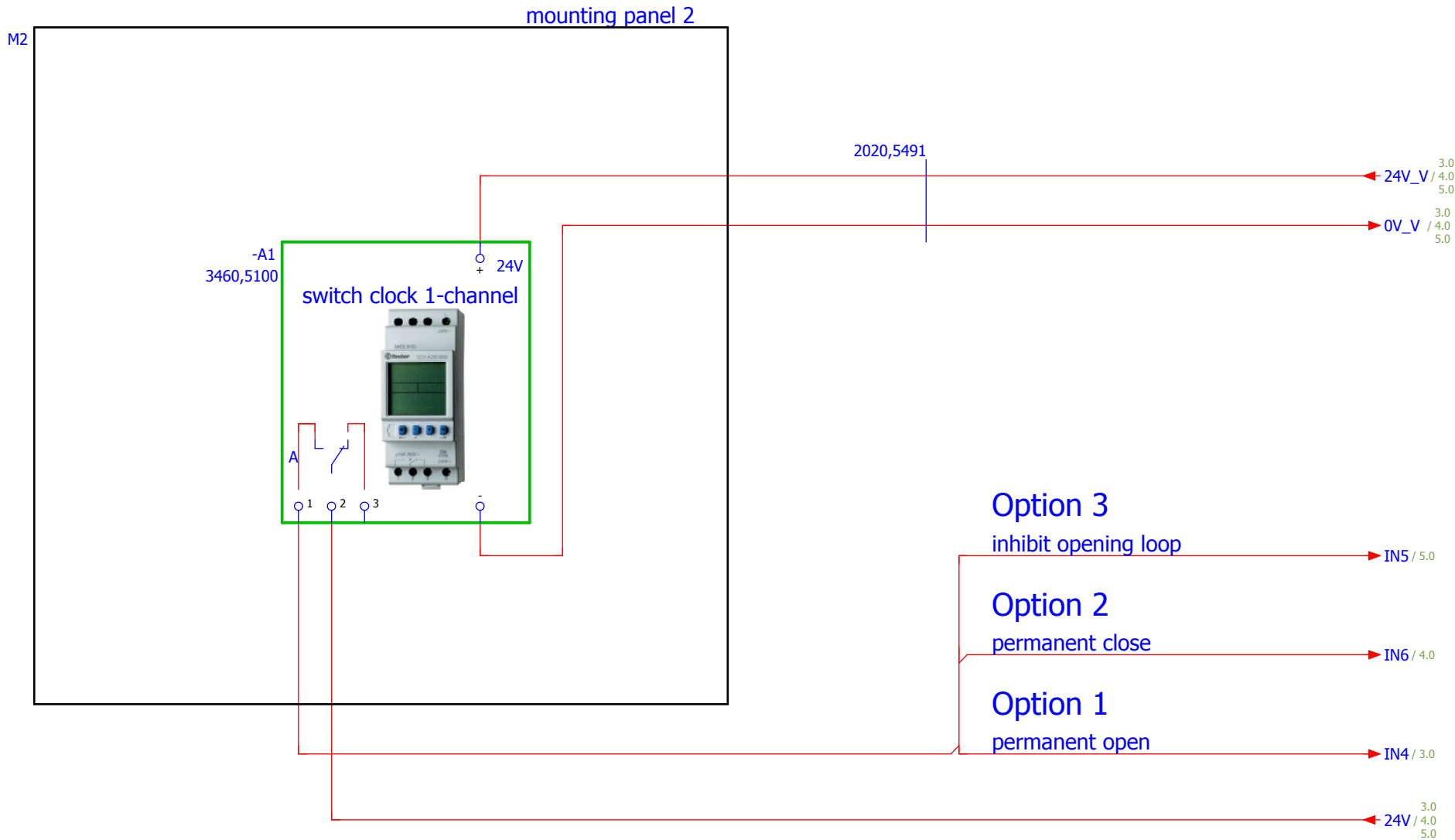

				06.12.2011
				gp
01	16.04.14	5K14513	gp	
Version	Date	Modification project	Name	00 5K11567

MHTM
MicroDrive



mounting panel 2
switch clock 1-channel

		=	
		+	
		5526,0002	Page 2
			of 5

Option 1

-A2



barrier controller MGC

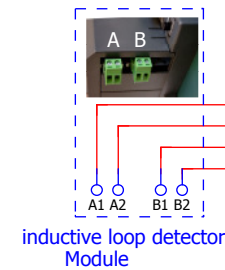
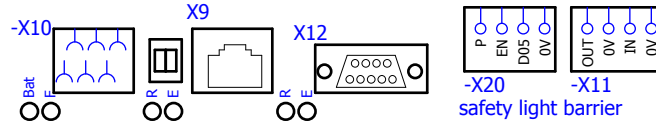

Transistor Outputs

Relay Outputs

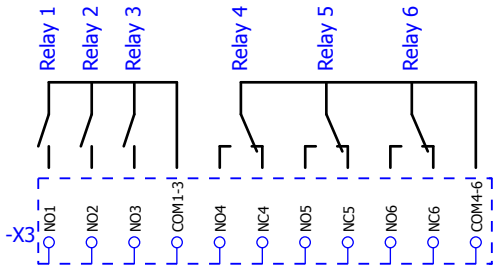
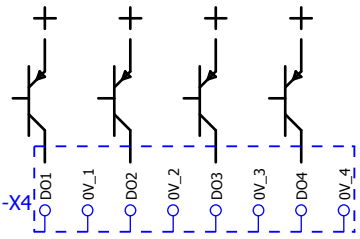
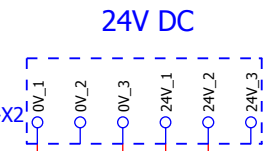
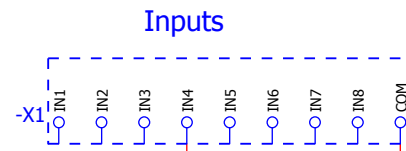

open 4 high priority

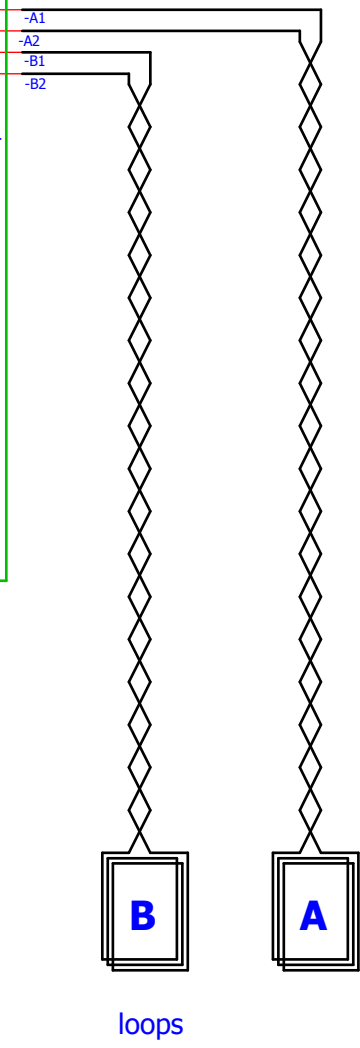
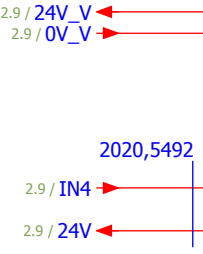

01	16.04.14	5K14513	gp	06.12.2011	MHTM
Version	Date	Modification project	Name	00 5K11567	MicroDrive



Option1 permanent open

Option 2

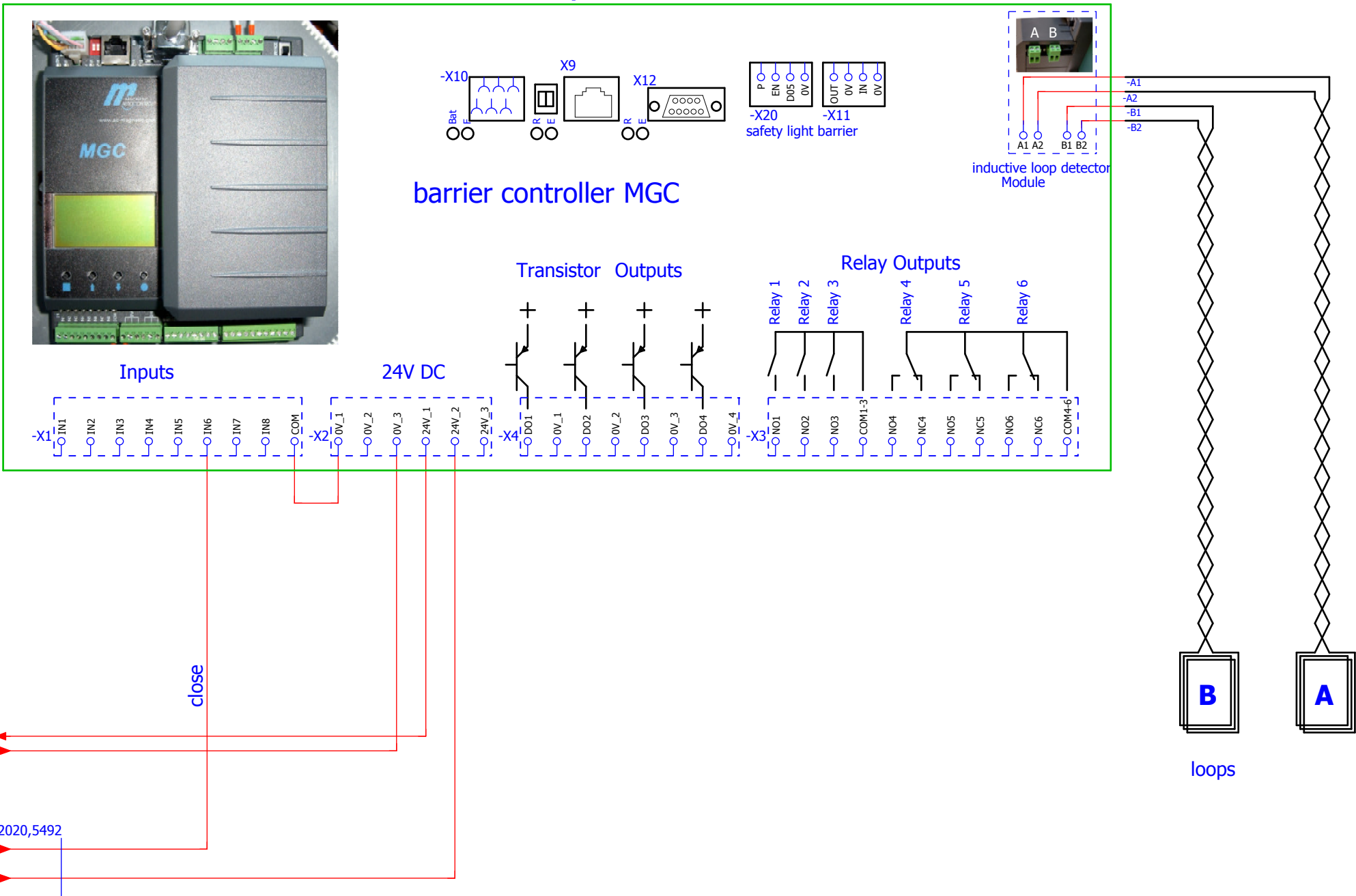

				06.12.2011
				gp
01	16.04.14	5K14513	gp	
Version	Date	Modification project	Name	00 5K11567

MHTM
MicroDrive



Option2
permanent close

Option 3

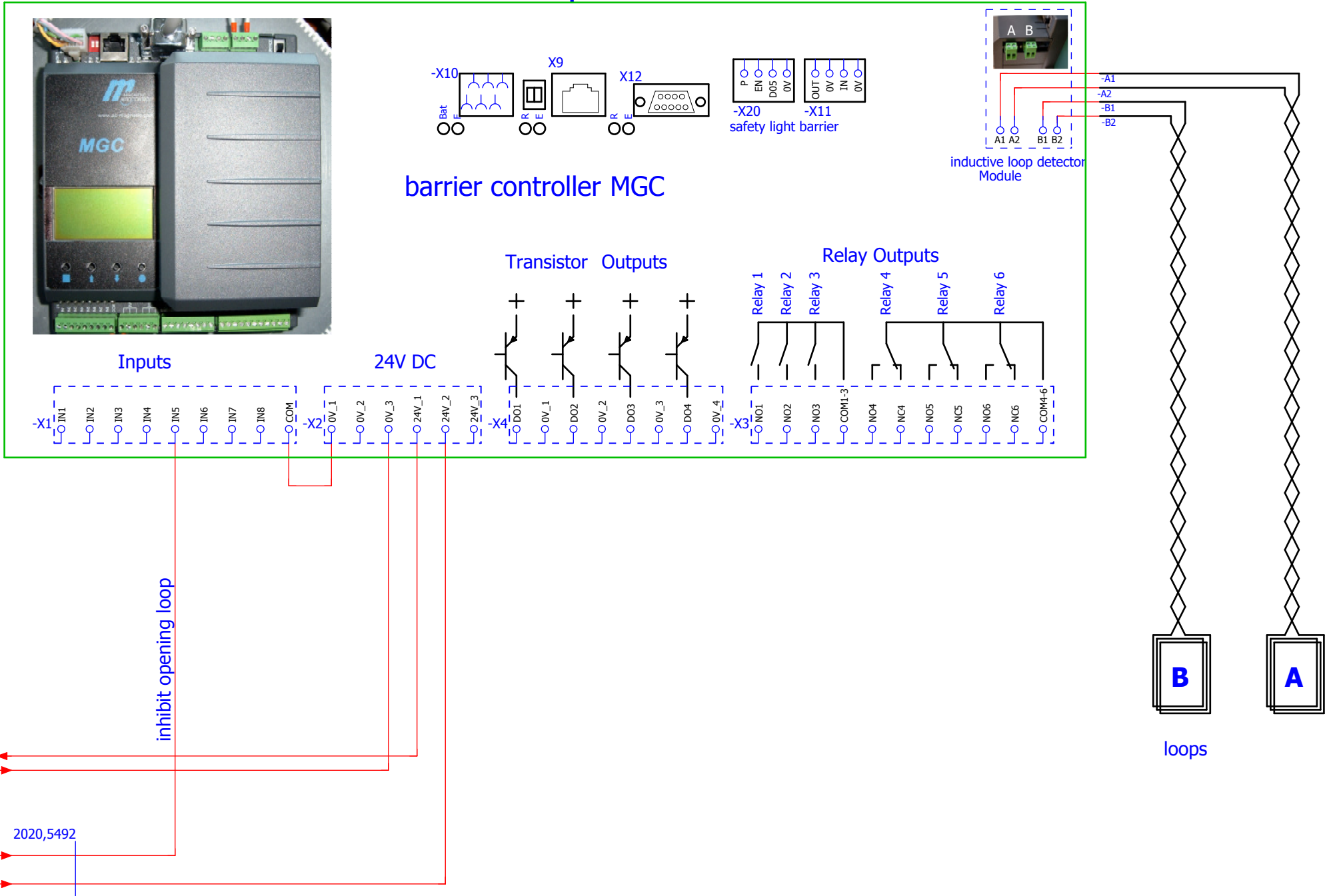

inhibit opening loop

loops

2.9 / 24V_V
2.9 / 0V_V

2020,5492

2.9 / IN5

2.9 / 24V